

Revision	ECN	Description	Issued by	Date
A		Official release	Max Liu	2020-04-24

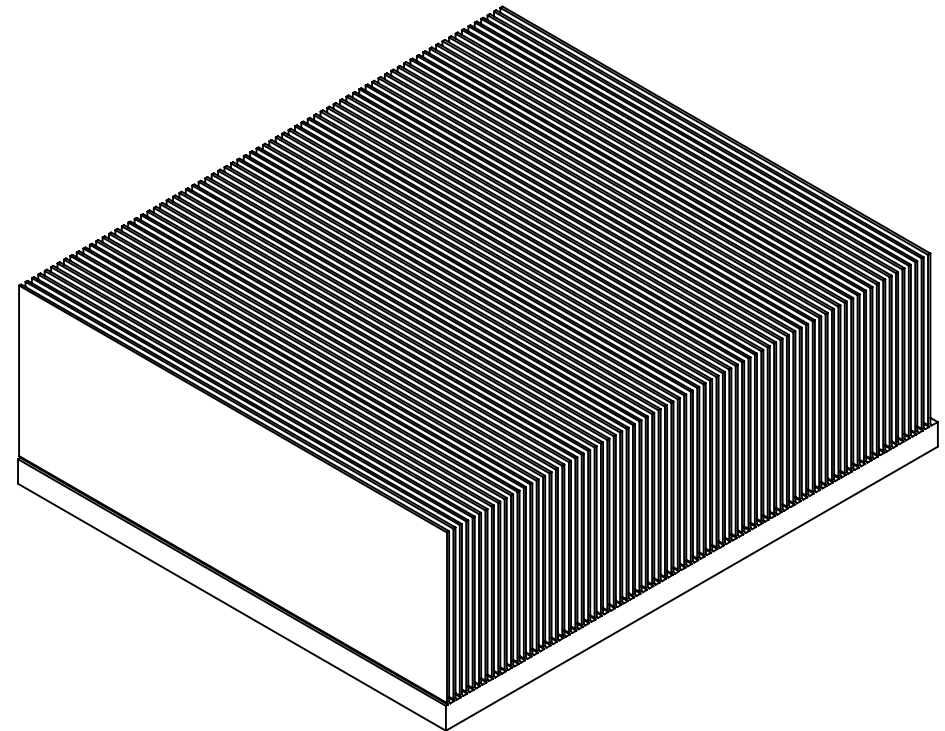
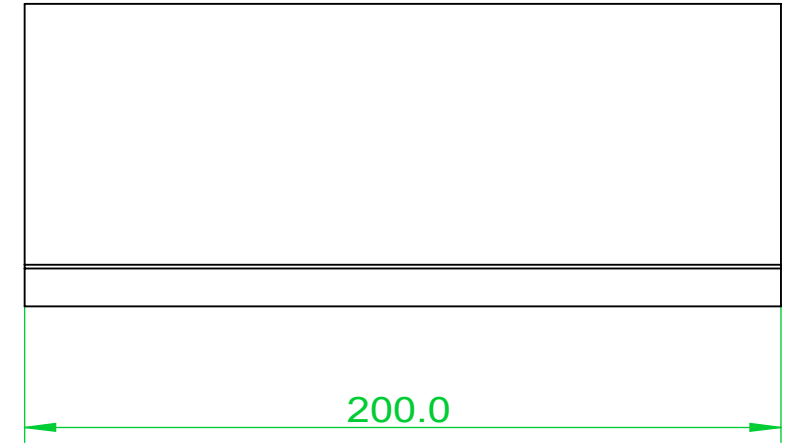

Notes,

1. Remove all burrs and sharp edges,
2. Part must be free from oil, dirt and other contaminants,
3. General tolerance: ISO2768-1m,
4. Part must be RoHS compliant.
5. Fin quantity: 76+/-2pcs.

Part number:	KF-HS-20-SK005	Revision	A	Third angle Projection		
Description:	Skiving Heat sink,600w					
Material:	Al 1060					
Designed by	Checked by	Approved by	Release date	Scale:	Units:	Sheet
Max Liu	Max Liu	King Li	2020-04-24	1:1	mm	1(1)